

"Cup Cakes"

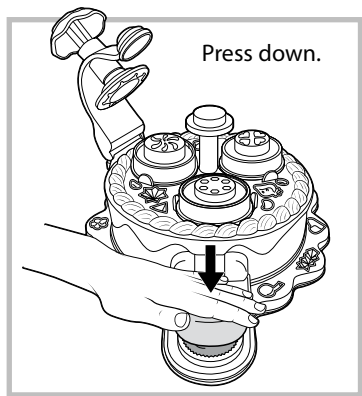

AGES
3+
24373

Cake Makin' Station™

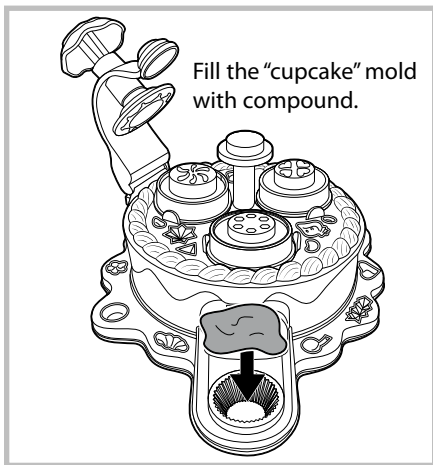

PLAY-DOH and the PLAY-DOH logo are trademarks identifying quality modeling compound products produced exclusively by Hasbro, Inc.



© 2009 Hasbro. All Rights Reserved.
TM & ® denote U.S. Trademarks.
U.S. Patent No. 6713624. P/N 7032470000

**NOTICE TO PARENTS: CONTAINS WHEAT.
NONTOXIC. CONFORMS TO ASTM D-4236.**

CONTENTS:

CAKE MAKIN' STATION base, 4 cake molds, plastic knife, 3 stamping molds, frosting tool, plate, spoon, fork, 2 cake layer cutters, roller, recipe card, instructions and 4 three-ounce cans of PLAY-DOH® Brand Modeling Compound (Net wt. 12 oz., 340 g).

ASSEMBLY:

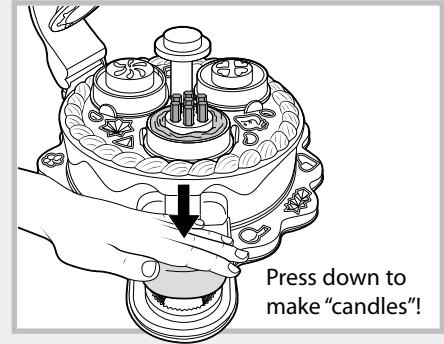
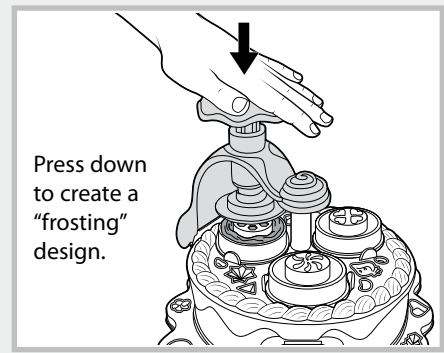
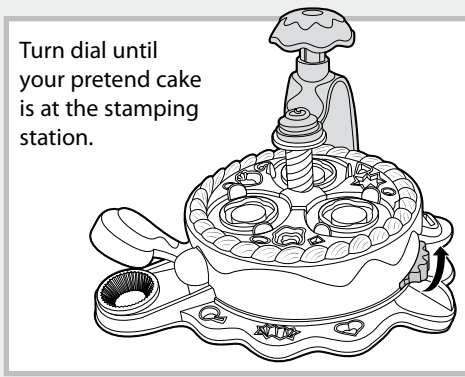
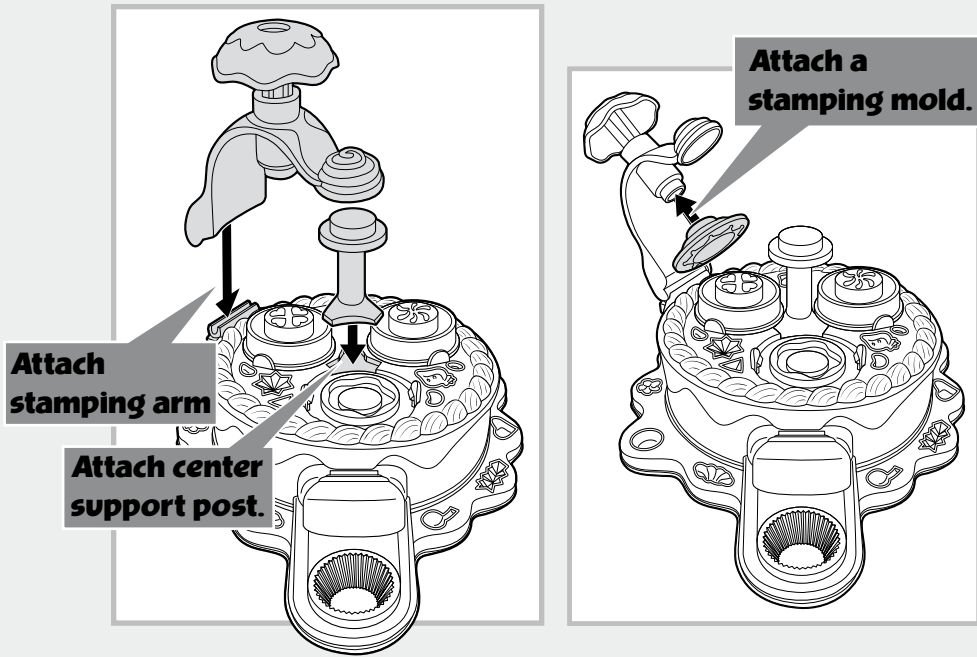

How to make PLAY-DOH cakes with the CAKE MAKIN' STATION

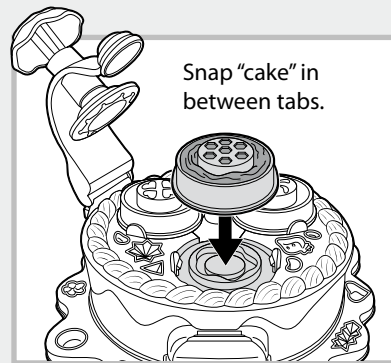
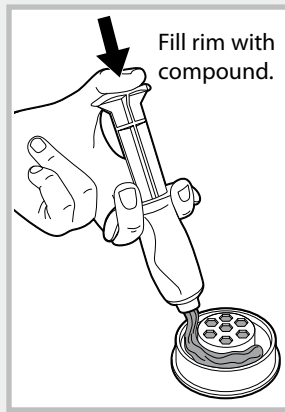
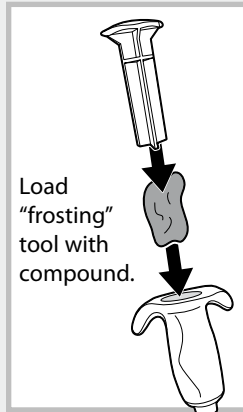
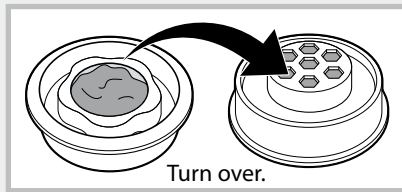
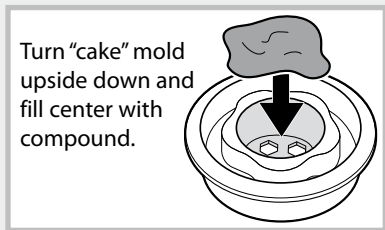

Here are more FRESH IDEAS™

"Cake" Decorations

There are 16 fun molds on your CAKE MAKIN STATION playset. Make lots of decorations for your PLAY-DOH cakes!

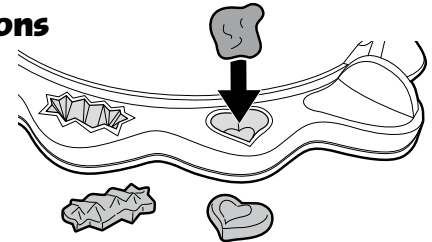

"Layer Cake"

You can also create layers with the cutters.

